













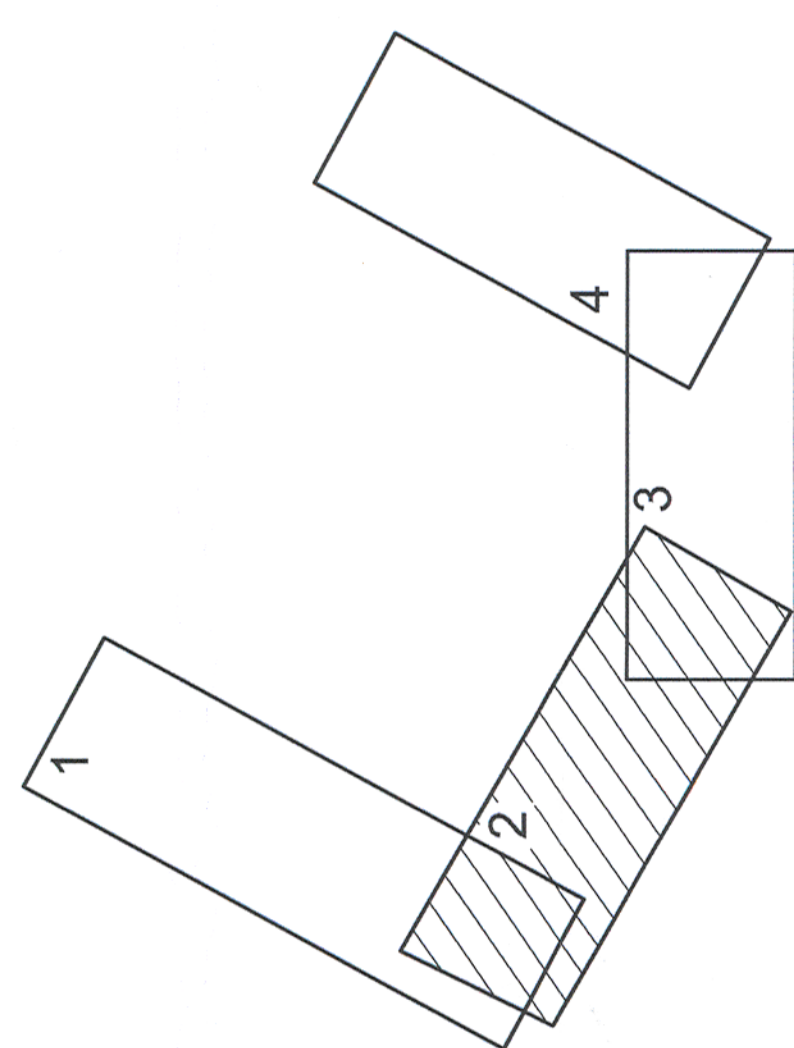

LEGENDA:

-  Tablou electric / Electric panel
-  Stîlp, lăvă OL-Zn, L = 8,00 / Lantern pole OL-Zn pipe, L = 8,00 m
-  Stîlp, lăvă OL-Zn, L = 8,00 / Lantern pole OL-Zn pipe, L = 8,00 m, class II, IP65 / Lighting unit equipped with sodium lamp, 150W, 230V, 50Hz, class II, IP65
-  Traversare lăvă PVC-KG, SNB, din stîlp în stîlp (de iluminat); / Crossing from one lantern pole to another, with PVC-KG tube, SNB;
-  Cablu cu conductoare de cupru de tip CYY-F pentru circuite de iluminat, cu izolație PVC montat în țevă; Lighting copper conductor cable CYY-F type, PVC insulated, installed in tube;
-  Plăvă OL-Zn 40x4 mm, montată la h=0,80 m față de cota finisă a podului; / OL-Zn flatband 40x4 mm, mounted at a depth of 0,80 m from the bridge final level;
-  Electrozi verticali confecționați din OL-Zn, având lungimea de h=2,5 m și diametrul de d=0,06 m, montați la o adâncime de h=0,80 m față de cota finisă a terenului; / Vertical electrodes made of OL-Zn, with a length of h=2,5 m and a diameter of d=0,06 m, mounted at a depth of h=0,80 m from the ground's final level;
-  Cămin de țigare cabluri, 1,20x1,20 m<sup>2</sup> / Cables manhole, 1,20x1,20 m;



									
Verificator / Expert Checker / Expert		Cerințe / Requirements NR. 1736		Semnătura / Signature BENEFICIAR / BENEFICIARY:		Data / Date		Semnătura / Signature	
Referință / Reference 856/24.06-2013		Referință / Reference 856/24.06-2013		Referință / Reference 856/24.06-2013		Referință / Reference 856/24.06-2013		Referință / Reference 856/24.06-2013	
European Investment Bank		MINISTERUL TRANSPORTURILOR BENEFICIAR / BENEFICIARY:		COMPANIA NAȚIONALĂ DE CĂI FERATE "CFR" SA		C. Teodorescu D.A. Stănescu		01.2013 01.2013	
Aprobat / Approved Verificat / Checked		Șef de echipă / Team leader Expert Cheie / Key Expert		Subcontractant / Subcontractor		A.M. Baicu M. Ciocîrlan		01.2013 01.2013	
Adjunct Șef de echipă / Deputy Team leader		Inginer / Engineer		A.M. Baicu M. Ciocîrlan		01.2013 01.2013		01.2013 01.2013	
Proiectat / Designed		Inginer / Engineer		M. Ciocîrlan		01.2013		01.2013	
"Reabilitarea liniei 1 Frontiera - Curtici, Secțiune pentru circulația trenurilor cu viteze > 160 km/h" Pan - European "Rehabilitation of the Railway Line Border - Curtici - Simeria, component Part of the IV Pan - European Corridor with a maximum speed of 160 km/h" Section 2 - B: End Y Bărzava - End Y Iliaș		"Reabilitarea liniei 1 Frontiera - Curtici, Secțiune pentru circulația trenurilor cu viteze > 160 km/h" Pan - European "Rehabilitation of the Railway Line Border - Curtici - Simeria, component Part of the IV Pan - European Corridor with a maximum speed of 160 km/h" Section 2 - B: End Y Bărzava - End Y Iliaș		"Reabilitarea liniei 1 Frontiera - Curtici, Secțiune pentru circulația trenurilor cu viteze > 160 km/h" Pan - European "Rehabilitation of the Railway Line Border - Curtici - Simeria, component Part of the IV Pan - European Corridor with a maximum speed of 160 km/h" Section 2 - B: End Y Bărzava - End Y Iliaș		"Reabilitarea liniei 1 Frontiera - Curtici, Secțiune pentru circulația trenurilor cu viteze > 160 km/h" Pan - European "Rehabilitation of the Railway Line Border - Curtici - Simeria, component Part of the IV Pan - European Corridor with a maximum speed of 160 km/h" Section 2 - B: End Y Bărzava - End Y Iliaș		"Reabilitarea liniei 1 Frontiera - Curtici, Secțiune pentru circulația trenurilor cu viteze > 160 km/h" Pan - European "Rehabilitation of the Railway Line Border - Curtici - Simeria, component Part of the IV Pan - European Corridor with a maximum speed of 160 km/h" Section 2 - B: End Y Bărzava - End Y Iliaș	
Scara / Scale 1:2000		Revizita / Revision 1/05.2013		Cod desen / Drawing Code PT:25.04.10.IE.14C.002		Nr / No 02/05		Proiect și 35311.1 Faza / Phase: PTH+CS / TD+TS	
Denumire desen / Drawing name: Iluminat pasaj rutier - Bărzava Bărzava - Road passage lighting		Denumire desen / Drawing name: Iluminat pasaj rutier - Bărzava Bărzava - Road passage lighting		Denumire desen / Drawing name: Iluminat pasaj rutier - Bărzava Bărzava - Road passage lighting		Denumire desen / Drawing name: Iluminat pasaj rutier - Bărzava Bărzava - Road passage lighting		Denumire desen / Drawing name: Iluminat pasaj rutier - Bărzava Bărzava - Road passage lighting	